

ACCESS DOORS for accessing concealed equipment and utility lines

Choose VENTS
quality!

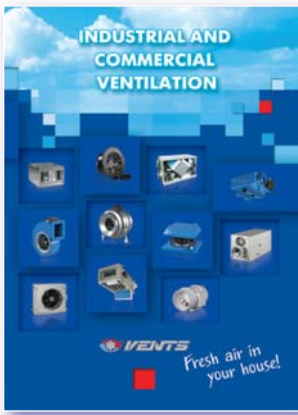

2013



Industrial and commercial ventilation
(Catalogue no. 1)

Industrial and commercial ventilation components - fans for round and rectangular ducts, sound-insulated, axial and roof fans, air handling units with heat recovery, air heating units, accessories.

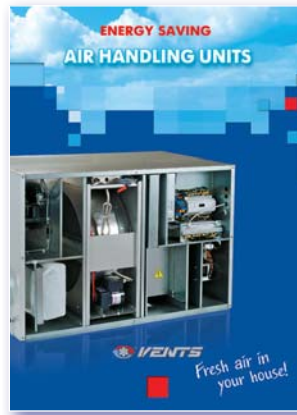

Energy saving ventilation
Air handling units
(Catalogue no. 2)

Energy saving supply and exhaust units and air handling units with heat recovery with air capacity up to 6500 m³/h.



Fire and smoke damper KPDU
(Catalogue no. 5)

Fire dampers KPDU for smoke protection systems of buildings and premises.

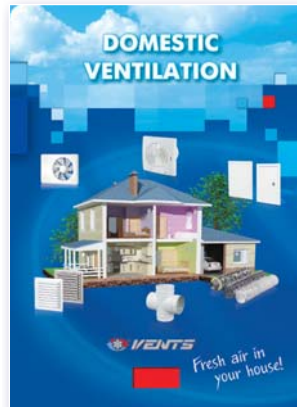

Domestic ventilation
(Catalogue no. 6)

Domestic ventilation: fans, mono-pipe exhaust kitchen and bathroom fans, air distribution units, air ducts and fittings, access doors, ventilation kits.



Air distribution units
(Catalogue no. 9)

Plastic and metal air distribution products (grilles, disk valves, diffusers, etc.) for ventilation, air conditioning and heating.

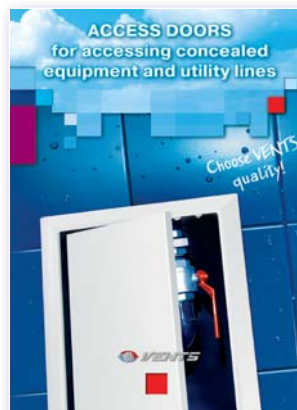

Access doors
(Catalogue no. 10)

Plastic and metal access doors for accessing concealed equipment and utility lines. Special offers for ceramic tiles.

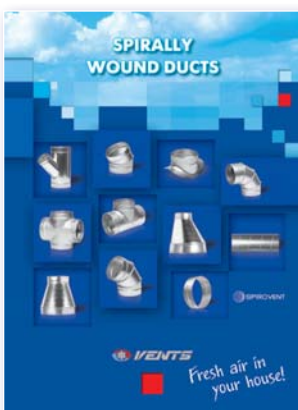

Spiral seam air ducts
(Catalogue no. 13)

SPIROVENT spiral seam vent ducts and fittings of 100 to 1600 mm diameter.



Flexible ducts and fittings for ventilation, air conditioning and heating
(Catalogue no. 14)

Flexible and semi-flexible air ducts made of polymeric materials, aluminium, galvanized or stainless steel, metal fittings for ventilation, air conditioning, heating, gas handling and abrasive particles aspiration.

DPM series

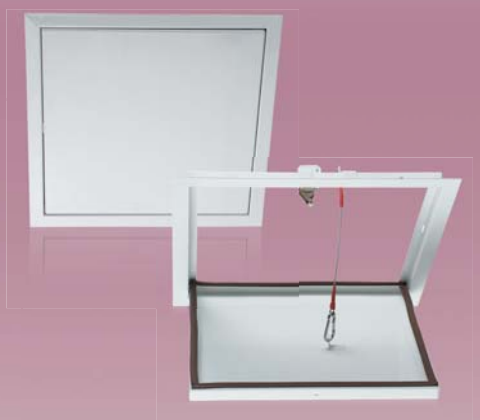

Access metal doors for ceiling mounting

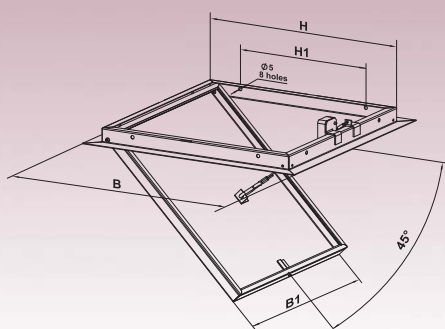

Applications

- Designed for ceiling applications.
- Enable quick and convenient access to concealed equipment and utility lines.
- Suitable for high-humidity areas.
- Protected by national patents worldwide.

Design

- Made of high-quality durable polymer-coated steel.
- The use of zinc phosphate compound ensures 100% coating integrity and provides a reliable corrosion protection.
- Specially designed mechanical lock provides a safe door fixation.

- Easy opening and closing with a slight pressing.
- Custom sizes are available upon request.
- The doors are equipped with a galvanized steel safety rope with a snap hook to retain doors in a position that enables inspection works.
- The door opening angle with a safety rope is 45°.
- Open the snap hook if a wider opening angle is required for inspections.
- The doors are lined with a sealant for tight connection between the doors and the frame.

Mounting

- Screw fixation to the ceiling-mounted aluminium shape.



Dimensions

Model	Dimensions, mm			
	□ B	□ B1	□ H	H1
DPM 300x300	336,5	296,5	298	200



**Air handling units
AIRVENTS
(Catalogue no. 3)**

Energy saving air handling units with air capacity up to 40 000 m³/h, for use in large residential, industrial and commercial objects.

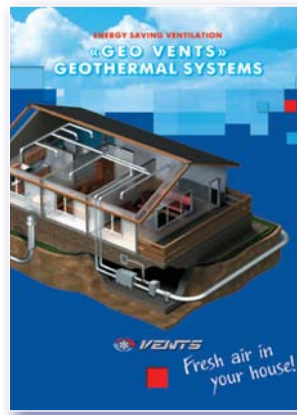

**Energy saving ventilation
Geothermal systems
GEO VENTS
(Catalogue no. 4)**

Energy saving system GEO VENTS with use of the earth's surface layers heat. High ventilation system energy efficiency and low operating costs.



**Domestic fans
(Catalogue no. 7)**

Domestic fans with air capacity up to 365 m³/h with extra functions: timer, humidity sensor, motion sensor, etc. Applied for premises up to 30 m².

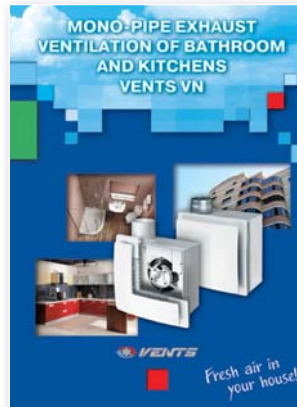

**VENTS VN
Mono-pipe exhaust
ventilation
(Catalogue no. 8)**

Exhaust ventilation in houses with mono-pipe ventilation system based on VENTS VN fans.



**Plastic grilles for ventilation
and air conditioning
(Catalogue no. 11)**

PROFIPLAST extruded plastic grilles for ventilation and air conditioning.

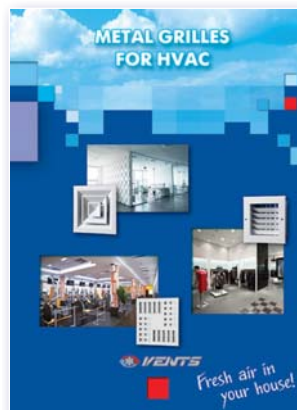

**Metal grilles for ventilation,
air conditioning and heating
(Catalogue no. 12)**

Metal grilles made of extruded metal profile for ventilation and air conditioning.

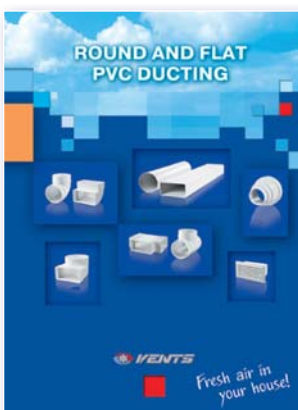

**Flat and round PVC
air ducts
(Catalogue no. 15)**

Flat and round PVC ducts PLASTIVENT for ventilation of residential, office and commercial premises and connection of exhaust ventilation equipment (kitchen extractors, hoods, exhaust boxes, etc). Wide product range of fittings.



**Energy saving ventilation.
Single room energy
recovery ventilators.
(Catalogue no. 16)**

Single room reverse ventilators with energy regeneration for efficient ventilation and lowest investments in ready-built and brand new premises.



CATALOGUES



CONTENT



**Access doors
D (D2) series**
Plastic

page
3



**Access doors
DZ series**
Plastic
(with lock)

page
4



**Access doors
DD series**
Plastic
(double sided hinges)

page
5



**Access doors
DM series**
Metal

page
6



**Access doors
DMZ series**
Metal
(with lock)

page
7



**Access doors
DMR series**
Metal

page
8



**Access doors
DMV series**
Metal

page
9



**Access doors
DKP series**
Recessed for
ceramic tiles

page
10



**Access doors
DKM series**
Recessed for
ceramic tiles

page
11



**Access doors
DG series**
Designed for plasterboard
wall or ceiling applications

page
12



**Access doors
DPM series**
Metal ceiling
mounted

page
13

D series



D2 series



Plastic access doors opening from either side

Applications

- Designed for wall or ceiling applications.
- Enable quick and convenient access to concealed equipment and utility lines.
- Suitable for high-humidity areas.
- Protected by national patents worldwide.

Design

- Made of high-quality ABS plastic.
- Left or right-side opening.

Sample installations

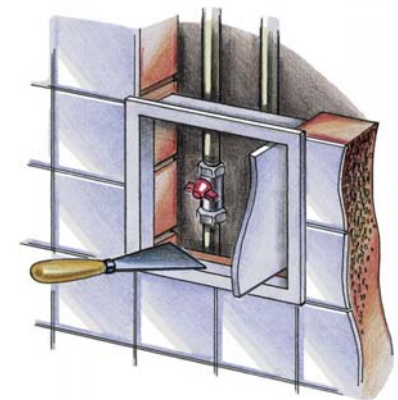
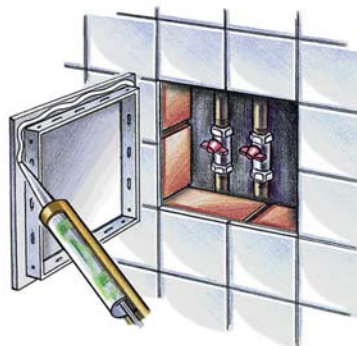

- Press gently to open and close.
- The swinging D2 doors provide maximum clearance while accessing utility lines.
- A wide range of sizes.

Mounting

- Easy mounting using mortar or glue.
- Universal mountings for left or right-side opening.
- Easy servicing.

Dimensions

Model	Dimensions, mm							
	H	B	H1	B1	H2	L1	L	B2
D 100x100	137	137	93	93	98	5	25	98
D 150x150	167	167	123	123	147	5	25	147
D 150x200	217	167	173	123	197	5	25	147
D 150x300	317	167	273	123	297	5	25	147
D 200x200	217	217	173	173	197	5	25	197
D 200x250	267	217	223	173	247	5	25	197
D 200x300	317	217	273	173	297	5	25	197
D 200x400	417	217	373	173	397	5	25	197
D 250x300	347	267	303	223	327	5	25	247
D 250x400	417	267	373	223	397	5	25	247
D 300x300	317	317	273	273	297	5	25	297
D 300x400	417	317	373	273	397	5	25	297
D 300x500	517	317	473	273	497	5	25	297
D 300x600	617	317	573	273	597	5	25	297
D 400x500	517	417	473	373	497	5	25	397
D 400x600	617	417	573	373	597	5	25	397
D2 400x400	416	388	372	344	397	5	25	370

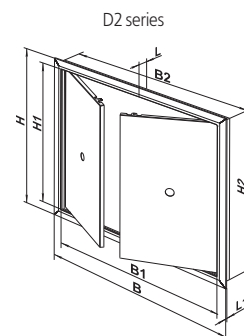
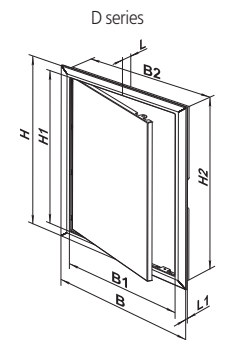

Color options



White



Beige



Grey



Sky Blue



Beige Marble



Grey Marble



Blue Marble



Green Marble

DZ series



Plastic access doors with key lock

Applications

- Designed for wall or ceiling applications.
- Enable quick and convenient access to concealed equipment and utility lines.
- Suitable for high-humidity areas.
- Protected by national patents worldwide.

Design

- Made of high-quality ABS plastic.
- Left or right-side opening.
- Equipped with a key lock.

Mounting

- Easy mounting using mortar or glue.
- Universal mountings for left or right-side opening.
- Easy servicing.

Sample installations

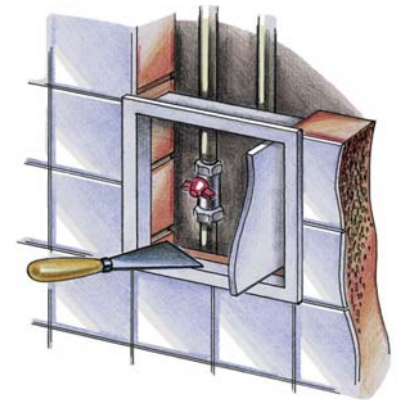
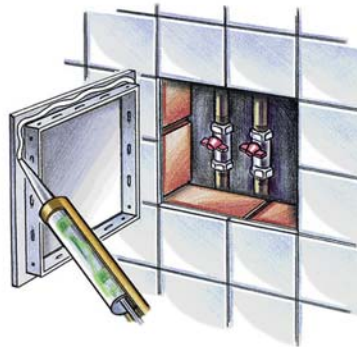

Dimensions

Model	Dimensions, mm							
	H	B	H1	B1	H2	L1	L	B2
DZ 150x300	317	167	273	123	297	5	25	147
DZ 250x400	417	267	373	223	397	5	25	247
DZ 300x500	517	317	473	273	497	5	25	297
DZ 300x600	617	317	573	273	597	5	25	297
DZ 400x500	517	417	473	373	497	5	25	397
DZ 400x600	617	417	573	373	597	5	25	397

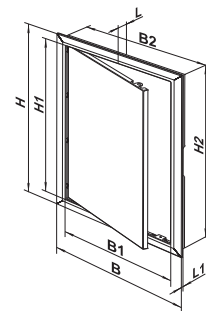

Color options



White



Beige



Grey



Sky Blue



Beige Marble



Grey Marble



Blue Marble



Green Marble

DD series



Plastic access doors with double-sided hinges and paint-ready surface

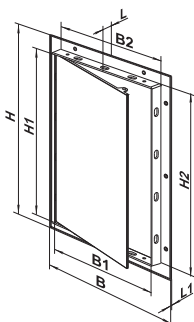
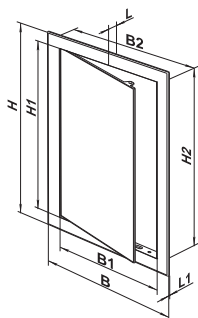

Applications

- Designed for wall or ceiling applications.
- Enable quick and convenient access to concealed equipment and utility lines.
- Concealed mounting for esthetic appearance.
- Suitable for high-humidity areas.
- Protected by national patents worldwide.

Design

- Made of high-quality ABS plastic.
- The door surface is ready for acrylic

and water-dispersion paint or wallpaper application.

- Left or right-side opening.
- Press gently to open and close.
- A wide range of sizes.

Mounting

- Easy mounting using mortar or glue.
- Universal mountings for left or right-side opening.
- Double-sided hinges.
- Easy servicing.

Sample installations

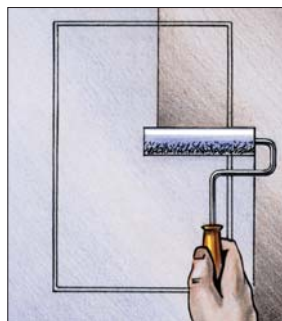

Dimensions

Model	Dimensions, mm							
	H	B	H1	B1	H2	L1	L	B2
DD 200x300	336	236	291	189	297	3	20	197

Color options



White



Beige



Grey



Sky Blue



Beige Marble



Grey Marble



Blue Marble



Green Marble

DM series



Metal access doors



Magnetic latch

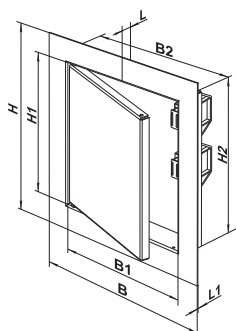

Applications

- Designed for wall applications.
- Enable quick and convenient access to concealed equipment and utility lines.
- Suitable for high-humidity areas.
- Protected by national patents worldwide.

Design

- Made of high-quality steel with a durable powder coating.
- The use of zinc phosphate compound ensures 100% coating integrity and provides a reliable corrosion protection.

- Left or right-side opening.
- Equipped with a magnetic latch for convenient opening and closing by gentle pressure.
- A wide range of sizes.
- Custom sizes are available upon request.

Mounting

- Easy mounting using mortar or glue.
- Universal mountings for left or right-side opening.
- Easy servicing.

Dimensions

Model	Dimensions, mm						
	H	B	H1	B2	H2	B1	L
DM 100x100	136,5	136,5	96,5	98,1	98,1	96,5	25
DM 150x150	186,5	186,5	146,5	148,1	148,1	146,5	25
DM 150x200	236,5	186,5	196,5	148,1	198,1	146,5	25
DM 150x250	286,5	186,5	246,5	148,1	248,1	146,5	25
DM 150x300	336,5	186,5	296,5	148,1	298,1	146,5	25
DM 200x200	236,5	236,5	196,5	198,1	198,1	196,5	25
DM 200x250	286,5	236,5	246,5	198,1	248,1	196,5	25
DM 200x300	336,5	236,5	296,5	198,1	298,1	196,5	25
DM 200x350	386,5	236,5	346,5	198,1	348,1	196,5	25
DM 200x400	436,5	236,5	396,5	198,1	398,1	196,5	25
DM 200x500	536,5	236,5	496,5	198,1	498,1	196,5	25
DM 225x300	336,5	261,5	296,5	223,1	298,1	221,5	25
DM 225x590	626,5	261,5	586,5	223,1	588,1	221,5	25
DM 250x250	286,5	286,5	246,5	248,1	248,1	246,5	25
DM 250x300	336,5	286,5	296,5	248,1	298,1	246,5	25
DM 250x350	386,5	286,5	346,5	248,1	348,1	246,5	25
DM 250x400	436,5	286,5	396,5	248,1	398,1	246,5	25
DM 250x450	486,5	286,5	446,5	248,1	448,1	246,5	25
DM 300x200	236,5	336,5	196,5	298,1	198,1	296,5	25
DM 300x300	336,5	336,5	296,5	298,1	298,1	296,5	25
DM 300x400	436,5	336,5	396,5	298,1	398,1	296,5	25
DM 300x500	536,5	336,5	496,5	298,1	498,1	296,5	25
DM 300x600	636,5	336,5	596,5	298,1	598,1	296,5	25
DM 350x350	386,5	386,5	346,5	348,1	348,1	346,5	25
DM 400x400	436,5	436,5	396,5	398,1	398,1	396,5	25
DM 400x500	536,5	436,5	496,5	398,1	498,1	396,5	25
DM 400x600	636,5	436,5	596,5	398,1	598,1	396,5	25
DM 450x250	286,5	486,5	246,5	448,1	248,1	446,5	25
DM 450x450	486,5	486,5	446,5	448,1	448,1	446,5	25
DM 500x500	536,5	536,5	496,5	498,1	498,1	496,5	25
DM 500x600	636,5	536,5	596,5	498,1	598,1	496,5	25
DM 500x800	836,5	536,5	796,5	498,1	798,1	496,5	25
DM 555x555	591,5	591,5	551,5	553,1	553,1	551,5	25
DM 600x400	436,5	636,5	396,5	598,1	398,1	596,5	25
DM 600x600	636,5	636,5	596,5	598,1	598,1	596,5	25
DM 600x800	836,5	636,5	796,5	598,1	798,1	596,5	25

Color options



White



Beige



Brown



Grey



Sky Blue



Black

DMZ series



Metal access doors



Key lock

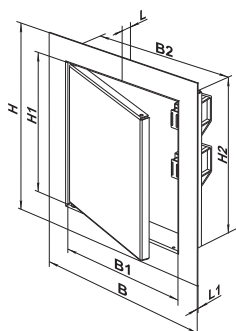

Applications

- Designed for wall or ceiling applications.
- Enable quick and convenient access to concealed equipment and utility lines.
- Suitable for high-humidity areas.
- Protected by national patents worldwide.

Design

- Made of high-quality steel with a durable powder coating.
- The use of zinc phosphate compound ensures 100% coating integrity and provides a reliable corrosion protection.

- Left or right-side opening.
- Equipped with a key lock.
- A wide range of sizes.
- Custom sizes are available upon request.

Mounting

- Easy mounting using mortar or glue.
- Universal mountings for left or right-side opening.
- Easy servicing.

Dimensions

Model	Dimensions, mm						
	H	B	H1	B2	H2	B1	L
DMZ 100x100	136,5	136,5	96,5	98,1	98,1	96,5	25
DMZ 150x150	186,5	186,5	146,5	148,1	148,1	146,5	25
DMZ 150x200	236,5	186,5	196,5	148,1	198,1	146,5	25
DMZ 150x250	286,5	186,5	246,5	148,1	248,1	146,5	25
DMZ 150x300	336,5	186,5	296,5	148,1	298,1	146,5	25
DMZ 200x200	236,5	236,5	196,5	198,1	198,1	196,5	25
DMZ 200x250	286,5	236,5	246,5	198,1	248,1	196,5	25
DMZ 200x300	336,5	236,5	296,5	198,1	298,1	196,5	25
DMZ 200x350	386,5	236,5	346,5	198,1	348,1	196,5	25
DMZ 200x400	436,5	236,5	396,5	198,1	398,1	196,5	25
DMZ 200x500	536,5	236,5	496,5	198,1	498,1	196,5	25
DMZ 225x300	336,5	261,5	296,5	223,1	298,1	221,5	25
DMZ 225x590	626,5	261,5	586,5	223,1	588,1	221,5	25
DMZ 250x250	286,5	286,5	246,5	248,1	248,1	246,5	25
DMZ 250x300	336,5	286,5	296,5	248,1	298,1	246,5	25
DMZ 250x350	386,5	286,5	346,5	248,1	348,1	246,5	25
DMZ 250x400	436,5	286,5	396,5	248,1	398,1	246,5	25
DMZ 250x450	486,5	286,5	446,5	248,1	448,1	246,5	25
DMZ 300x200	236,5	336,5	196,5	298,1	198,1	296,5	25
DMZ 300x300	336,5	336,5	296,5	298,1	298,1	296,5	25
DMZ 300x400	436,5	336,5	396,5	298,1	398,1	296,5	25
DMZ 300x500	536,5	336,5	496,5	298,1	498,1	296,5	25
DMZ 300x600	636,5	336,5	596,5	298,1	598,1	296,5	25
DMZ 350x350	386,5	386,5	346,5	348,1	348,1	346,5	25
DMZ 400x400	436,5	436,5	396,5	398,1	398,1	396,5	25
DMZ 400x500	536,5	436,5	496,5	398,1	498,1	396,5	25
DMZ 400x600	636,5	436,5	596,5	398,1	598,1	396,5	25
DMZ 450x250	286,5	486,5	246,5	448,1	248,1	446,5	25
DMZ 450x450	486,5	486,5	446,5	448,1	448,1	446,5	25
DMZ 500x500	536,5	536,5	496,5	498,1	498,1	496,5	25
DMZ 500x600	636,5	536,5	596,5	498,1	598,1	496,5	25
DMZ 500x800	836,5	536,5	796,5	498,1	798,1	496,5	25
DMZ 555x555	591,5	591,5	551,5	553,1	553,1	551,5	25
DMZ 600x400	436,5	636,5	396,5	598,1	398,1	596,5	25
DMZ 600x600	636,5	636,5	596,5	598,1	598,1	596,5	25
DMZ 600x800	836,5	636,5	796,5	598,1	798,1	596,5	25

Color options



White



Beige



Brown



Grey



Sky Blue



Black

DMR series



Metal access doors with a plastic handle



Plastic handle provides additional convenience while opening and closing

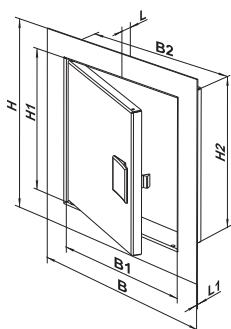

Applications

- Designed for wall applications.
- Enable quick and convenient access to concealed equipment and utility lines.
- Suitable for high-humidity areas.
- Protected by national patents worldwide.

Design

- Made of high-quality steel with a durable powder coating.
- The use of zinc phosphate compound ensures 100% coating integrity and provides a

reliable corrosion protection.

- Left or right-side opening.
- Equipped with a plastic handle for easy opening and closing.
- A wide range of sizes.
- Custom sizes are available upon request.

Mounting

- Easy mounting using mortar or glue.
- Universal mountings for left or right-side opening.
- Easy servicing.

Dimensions

Model	Dimensions, mm						
	H	B	H1	B2	H2	B1	L
DMR 100x100	136,5	136,5	96,5	98,1	98,1	96,5	25
DMR 150x150	186,5	186,5	146,5	148,1	148,1	146,5	25
DMR 150x200	236,5	186,5	196,5	148,1	198,1	146,5	25
DMR 150x250	286,5	186,5	246,5	148,1	248,1	146,5	25
DMR 150x300	336,5	186,5	296,5	148,1	298,1	146,5	25
DMR 200x200	236,5	236,5	196,5	198,1	198,1	196,5	25
DMR 200x250	286,5	236,5	246,5	198,1	248,1	196,5	25
DMR 200x300	336,5	236,5	296,5	198,1	298,1	196,5	25
DMR 200x350	386,5	236,5	346,5	198,1	348,1	196,5	25
DMR 200x400	436,5	236,5	396,5	198,1	398,1	196,5	25
DMR 225x300	336,5	261,5	296,5	223,1	298,1	221,5	25
DMR 225x590	626,5	261,5	586,5	223,1	588,1	221,5	25
DMR 250x250	286,5	286,5	246,5	248,1	248,1	246,5	25
DMR 250x300	336,5	286,5	296,5	248,1	298,1	246,5	25
DMR 250x350	386,5	286,5	346,5	248,1	348,1	246,5	25
DMR 250x400	436,5	286,5	396,5	248,1	398,1	246,5	25
DMR 250x450	486,5	286,5	446,5	248,1	448,1	246,5	25
DMR 300x200	236,5	336,5	196,5	298,1	198,1	296,5	25
DMR 300x300	336,5	336,5	296,5	298,1	298,1	296,5	25
DMR 300x400	436,5	336,5	396,5	298,1	398,1	296,5	25
DMR 300x500	536,5	336,5	496,5	298,1	498,1	296,5	25
DMR 300x600	636,5	336,5	596,5	298,1	598,1	296,5	25
DMR 350x350	386,5	386,5	346,5	348,1	348,1	346,5	25
DMR 400x400	436,5	436,5	396,5	398,1	398,1	396,5	25
DMR 400x500	536,5	436,5	496,5	398,1	498,1	396,5	25
DMR 400x600	636,5	436,5	596,5	398,1	598,1	396,5	25
DMR 450x250	286,5	486,5	246,5	448,1	248,1	446,5	25
DMR 450x450	486,5	486,5	446,5	448,1	448,1	446,5	25
DMR 500x500	536,5	536,5	496,5	498,1	498,1	496,5	25
DMR 500x600	636,5	536,5	596,5	498,1	598,1	496,5	25
DMR 500x800	836,5	536,5	796,5	498,1	798,1	496,5	25
DMR 555x555	591,5	591,5	551,5	553,1	553,1	551,5	25
DMR 600x400	436,5	636,5	396,5	598,1	398,1	596,5	25
DMR 600x600	636,5	636,5	596,5	598,1	598,1	596,5	25
DMR 600x800	836,5	636,5	796,5	598,1	798,1	596,5	25

Color options



White



Beige



Brown



Grey



Sky Blue



Black

DMV series



Metal access doors with ventilation openings

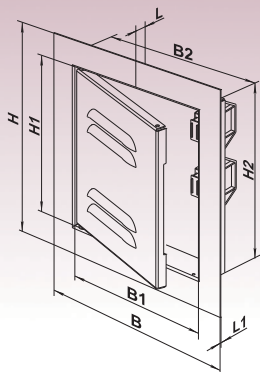

Applications

- Designed for wall applications.
- Enable quick and convenient access to concealed equipment and utility lines.
- Suitable for high-humidity areas.
- Protected by national patents worldwide.

Design

- Made of high-quality steel with a durable powder coating.
- The use of zinc phosphate compound ensures 100% coating integrity and provides a reliable corrosion protection.

- Ventilation openings supply additional air into the space behind the door.
- Left or right-side opening.
- Equipped with a plastic handle for easy opening and closing.
- A wide range of sizes.
- Custom sizes are available upon request.

Mounting

- Easy mounting using mortar or glue.
- Universal mountings for left or right-side opening.
- Easy servicing.

Dimensions

Model	Dimensions, mm						
	H	B	H1	B2	H2	B1	L
DMV 100x100	136,5	136,5	96,5	98,1	98,1	96,5	25
DMV 150x150	186,5	186,5	146,5	148,1	148,1	146,5	25
DMV 150x200	236,5	186,5	196,5	148,1	198,1	146,5	25
DMV 150x250	286,5	186,5	246,5	148,1	248,1	146,5	25
DMV 150x300	336,5	186,5	296,5	148,1	298,1	146,5	25
DMV 200x200	236,5	236,5	196,5	198,1	198,1	196,5	25
DMV 200x250	286,5	236,5	246,5	198,1	248,1	196,5	25
DMV 200x300	336,5	236,5	296,5	198,1	298,1	196,5	25
DMV 200x350	386,5	236,5	346,5	198,1	348,1	196,5	25
DMV 200x400	436,5	236,5	396,5	198,1	398,1	196,5	25
DMV 225x300	336,5	261,5	296,5	223,1	298,1	221,5	25
DMV 225x590	626,5	261,5	586,5	223,1	588,1	221,5	25
DMV 250x250	286,5	286,5	246,5	248,1	248,1	246,5	25
DMV 250x300	336,5	286,5	296,5	248,1	298,1	246,5	25
DMV 250x350	386,5	286,5	346,5	248,1	348,1	246,5	25
DMV 250x400	436,5	286,5	396,5	248,1	398,1	246,5	25
DMV 250x450	486,5	286,5	446,5	248,1	448,1	246,5	25
DMV 300x200	236,5	336,5	296,5	298,1	198,1	196,5	25
DMV 300x300	336,5	336,5	296,5	298,1	298,1	296,5	25
DMV 300x400	436,5	336,5	396,5	298,1	398,1	296,5	25
DMV 300x500	536,5	336,5	496,5	298,1	498,1	296,5	25
DMV 300x600	636,5	336,5	596,5	298,1	598,1	296,5	25
DMV 350x350	386,5	386,5	346,5	348,1	348,1	346,5	25
DMV 400x400	436,5	436,5	396,5	398,1	398,1	396,5	25
DMV 400x500	536,5	436,5	496,5	398,1	498,1	396,5	25
DMV 400x600	636,5	436,5	596,5	398,1	598,1	396,5	25
DMV 450x250	286,5	486,5	446,5	448,1	248,1	246,5	25
DMV 450x450	486,5	486,5	446,5	448,1	448,1	446,5	25
DMV 500x500	536,5	536,5	496,5	498,1	498,1	496,5	25
DMV 500x600	636,5	536,5	596,5	498,1	598,1	496,5	25
DMV 500x800	836,5	536,5	796,5	498,1	798,1	496,5	25
DMV 555x555	591,5	591,5	551,5	553,1	553,1	551,5	25
DMV 600x400	436,5	636,5	596,5	598,1	398,1	396,5	25
DMV 600x600	636,5	636,5	596,5	598,1	598,1	596,5	25
DMV 600x800	836,5	636,5	596,5	598,1	798,1	796,5	25

Color options



White



Beige



Brown



Grey



Sky Blue



Black

DKP series



Access doors on a PVC frame for attaching ceramic tiles

Sample installations

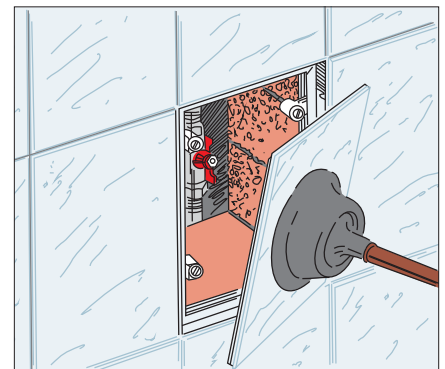
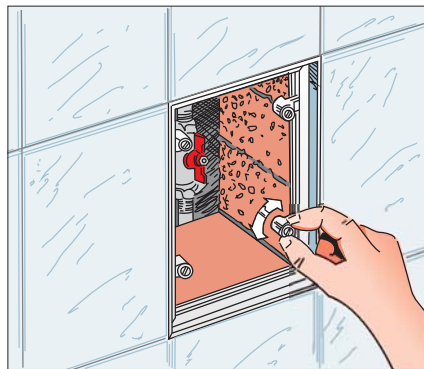

Applications

- Designed for wall installation and ceramic tile attachment.
- Enable quick and convenient access to concealed equipment and utility lines.
- Concealed mounting for esthetic appearance.
- Suitable for high-humidity areas.
- Protected by national patents worldwide.

Design

- The PVC profile frame contains magnets and hides the tile-to-tile gap.

- Metal plate for attaching ceramic tiles.
- Magnetic attachment of plate to the frame.
- Press gently to open and close or use a cup plunger.
- A wide range of sizes.

Mounting

- Easy installation using spacers lugs.
- Height-adjustable magnets enable perfect leveling of tiles to the wall surface.
- Ceramic tiles are easily glued to the plate.
- Easy servicing.

Dimensions

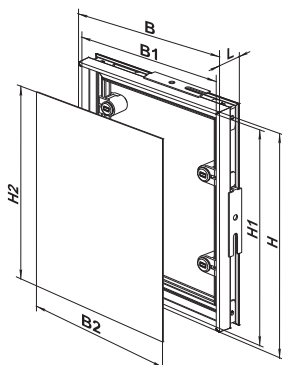

Model	Dimensions, mm						
	B	H	B2	H2	B1	H1	L
DKP 150x150	156	156	145	145	153	153	30
DKP 150x200	156	206	145	195	153	203	30
DKP 150x300	156	306	145	295	153	303	30
DKP 200x200	206	206	195	195	203	203	30
DKP 200x250	206	256	195	245	203	253	30
DKP 200x300	206	306	195	295	203	303	30
DKP 200x350	206	356	195	345	203	353	30
DKP 200x400	206	406	195	395	203	403	30
DKP 200x450	206	456	195	445	203	453	30
DKP 200x500	206	506	195	495	203	503	30
DKP 250x250	256	256	245	245	253	253	30
DKP 250x300	256	306	245	295	253	303	30
DKP 250x350	256	356	245	345	253	353	30
DKP 250x400	256	406	245	395	253	403	30
DKP 300x300	306	306	295	295	303	303	30
DKP 300x350	306	356	295	345	303	353	30
DKP 300x400	306	406	295	395	303	403	30
DKP 300x450	306	456	295	445	303	453	30
DKP 300x500	306	506	295	495	303	503	30
DKP 400x400	406	406	395	395	403	403	30

DKM series



Access doors on a metal frame recessed for ceramic tiles

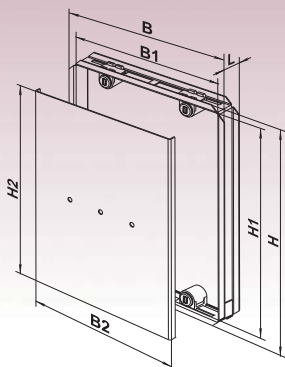

Applications

- Designed for wall installation and ceramic tile attachment.
- Enable quick and convenient access to concealed equipment and utility lines.
- Concealed mounting for esthetic appearance.
- Suitable for high-humidity areas.
- Protected by national patents worldwide.

Design

- The metal frame contains magnets for plate attachment and hides the tile-to-tile gap.

- Metal plate for attaching ceramic tiles.
- Magnetic attachment of plate to the frame.
- Press gently to open and close or use a cup plunger.
- A wide range of sizes.

Mounting

- Easy installation using mounting foam or mortar.
- Height-adjustable magnets enable perfect leveling of tiles to the wall surface.
- Ceramic tiles are easily glued to the plate.
- Easy servicing.

Sample Installations

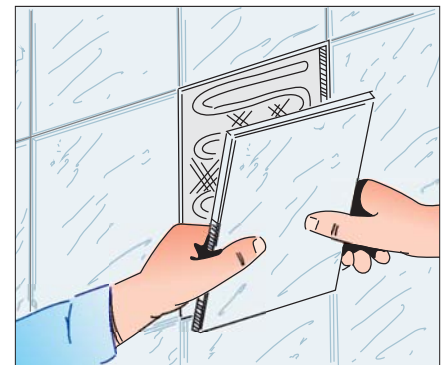
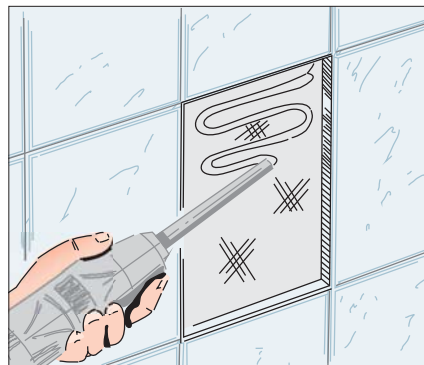

Dimensions

Model	Dimensions, mm				
	B	H	B2	H2	L
DKM 150x150	163,6	163,6	150	150	26
DKM 150x200	163,6	213,6	150	200	26
DKM 150x250	163,6	263,6	150	250	26
DKM 150x300	163,6	313,6	150	300	26
DKM 200x200	213,6	213,6	200	200	26
DKM 200x250	213,6	263,6	200	250	26
DKM 200x300	213,6	313,6	200	300	26
DKM 200x350	213,6	363,6	200	350	26
DKM 200x400	213,6	413,6	200	400	26
DKM 200x450	213,6	463,6	200	450	26
DKM 200x500	213,6	513,6	200	500	26
DKM 250x250	263,6	263,6	250	250	26
DKM 250x300	263,6	313,6	250	300	26
DKM 250x350	263,6	363,6	250	350	26
DKM 250x400	263,6	413,6	250	400	26
DKM 300x300	313,6	313,6	300	300	26
DKM 300x350	313,6	363,6	300	350	26
DKM 300x400	313,6	413,6	300	400	26
DKM 300x450	313,6	463,6	300	450	26
DKM 300x500	313,6	513,6	300	500	26
DKM 400x400	413,6	413,6	400	400	26
DKM 400x500	413,6	513,6	400	500	26
DKM 500x500	513,6	513,6	500	500	26
DKM 600x600	613,6	613,6	600	600	26

DG series



Access doors for plasterboard applications

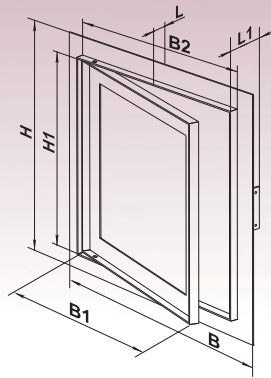

The special mechanism provides for secure locking

Applications

- Designed for plasterboard walls and ceilings 12.5 and 15 mm thick.
- Enable quick and convenient access to concealed equipment and utility lines.
- Suitable for high-humidity areas.
- Protected by national patents worldwide.

Design

- The main structural frame and panel frame are made of aluminum profile.
- The special mechanism ensures secure locking, large-size doors are equipped with double locks.

Sample Installations

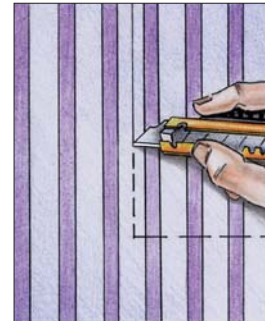

Dimensions

Model	Dimensions, mm					
	H/B	H1/B1	B2	L	L1	Number of locks
DG 200x200	260	196	204	15	55	1
DG 300x300	360	296	304	15	55	1
DG 400x400	460	396	404	15	55	2
DG 500x500	560	496	504	15	55	2
DG 600x600	660	596	604	15	55	2

- Left or right-side opening.
- Press gently to open and close.
- A wide range of sizes.
- Custom sizes are available upon request.

Mounting

- The doors are attached to aluminum profiles on self-tapping screws and flushed up with plasterboard on the front.
- Universal mountings for left or right-side opening.
- Easy servicing.

DPM series

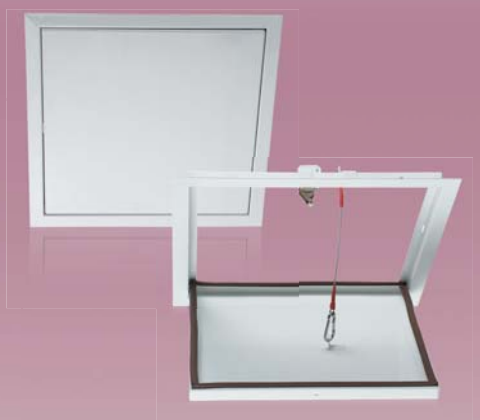

Access metal doors for ceiling mounting

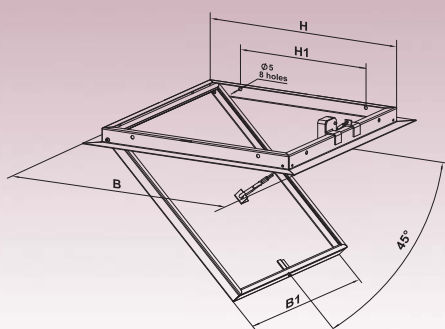

Applications

- Designed for ceiling applications.
- Enable quick and convenient access to concealed equipment and utility lines.
- Suitable for high-humidity areas.
- Protected by national patents worldwide.

Design

- Made of high-quality durable polymer-coated steel.
- The use of zinc phosphate compound ensures 100% coating integrity and provides a reliable corrosion protection.
- Specially designed mechanical lock provides a safe door fixation.

- Easy opening and closing with a slight pressing.
- Custom sizes are available upon request.
- The doors are equipped with a galvanized steel safety rope with a snap hook to retain doors in a position that enables inspection works.
- The door opening angle with a safety rope is 45°.
- Open the snap hook if a wider opening angle is required for inspections.
- The doors are lined with a sealant for tight connection between the doors and the frame.

Mounting

- Screw fixation to the ceiling-mounted aluminium shape.



Dimensions

Model	Dimensions, mm			
	□ B	□ B1	□ H	H1
DPM 300x300	336,5	296,5	298	200

VENTILATION SYSTEM
www.ventilation-system.com

access doors



VENTS reserves the rights to modify any of its products' features, designs, components and specifications at any time and without notice to maintain the development and quality of manufactured goods.

11/2013

